

PRODUCT DATA SHEET

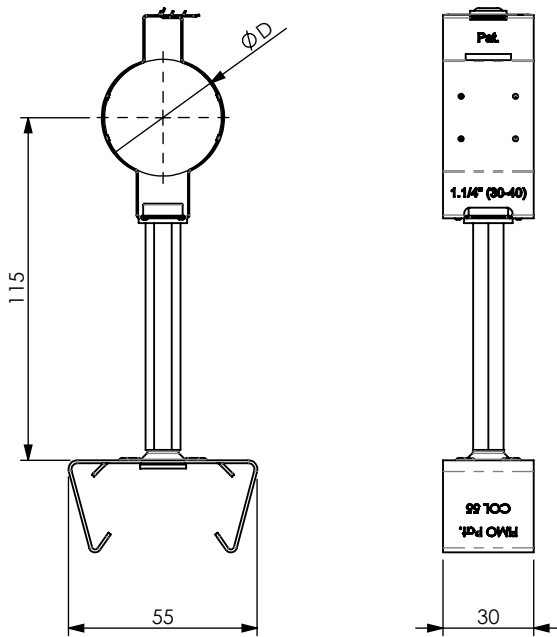

A) SPECIFICATIONS

- 1 SCC40 Click Collars for Cables and Pipes. Ratchet-tightening and opening by hand without tool. Monoblock body made of flexible Stainless Steel.
- 2 COL 55 Stainless Steel Snap on CLlip.
- 3 VSI 8x20 Stainless Steel Countersunk Head Socket Screw.
- 4 MEI 10/75 Stainless Steel Hexagonal Spacer.
- 5 REI 8 Stainless Steel Elastic Washer.
- 6 RPI 8/16 Stainless Steel Flat Washer.
- 7 VCI 8x20 Stainless Steel Hexagon Head Socket Screw.

B) DELIVERY MODALITIES

Packing in boxes. Label indicating: product code, article, quantity, production batch, FIMO logo and figure. (Customer code on request).

C) MOUNTING INSTRUCTIONS

On request

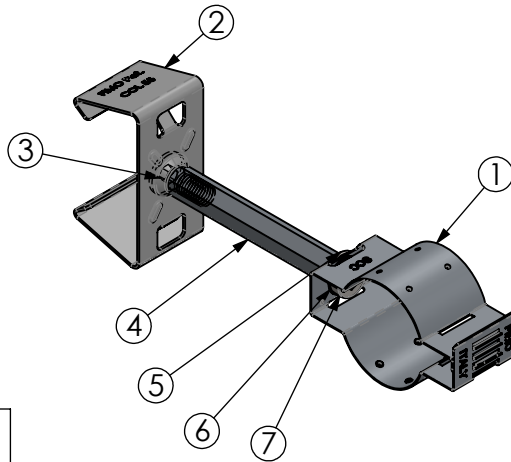

code	6120100040.55
article	KIT SCC 40 + COL 55

D		
30-40	50	0.1107kg

RI	DATE	DR	DATE	AP	Description: KIT SCC 40 + COL 55 Radiating Cable Clamps
02					
01					
00	05/11/2013	E.B.	05/11/2013	A.V.	
1 ST EMISSION					
					Use: Fixing of radiating cables on profiles/sections