

# PRODUCT DATA SHEET

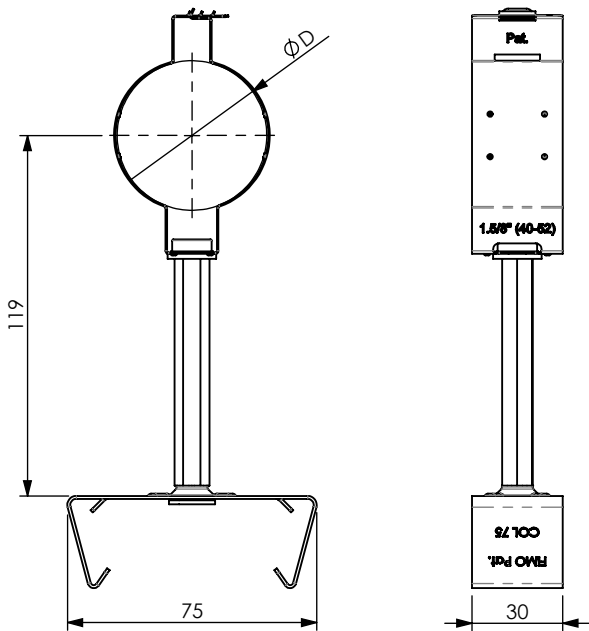

## A) SPECIFICATIONS

- 1 SCC50 Click Collars for Cables and Pipes. Ratchet-tightening and opening by hand without tool. Monoblock body made of flexible Stainless Steel.
- 2 COL 55 Stainless Steel Snap on CLlip.
- 3 VSI 8x20 Stainless Steel Countersunk Head Socket Screw.
- 4 MEI 10/75 Stainless Steel Hexagonal Spacer.
- 5 REI 8 Stainless Steel Elastic Washer.
- 6 RPI 8/16 Stainless Steel Flat Washer.
- 7 VCI 8x20 Stainless Steel Hexagon Head Socket Screw.

## B) DELIVERY MODALITIES

Packing in boxes. Label indicating: product code, article, quantity, production batch, FIMO logo and figure. (Customer code on request).

## C) MOUNTING INSTRUCTIONS

On request

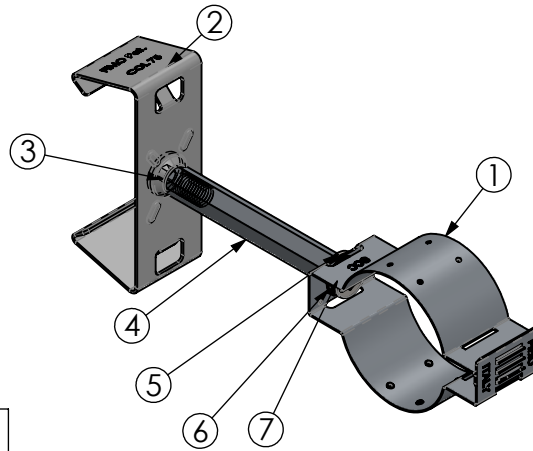

code	<b>6120100050.75</b>
article	KIT SCC 50 + COL 75

<b>D</b>		
40-52	50	0.1196kg

RI	DATE	DR	DATE	AP	Description:
02					<b>KIT SCC 50 + COL 75 Radiating Cable Clamps</b>
01					
00	17/12/2015	E.B.	17/12/2015	A.V.	
1 <sup>ST</sup> EMISSION					
					Use: Fixing of radiating cables on profiles/sections