

PRODUCT DATA SHEET

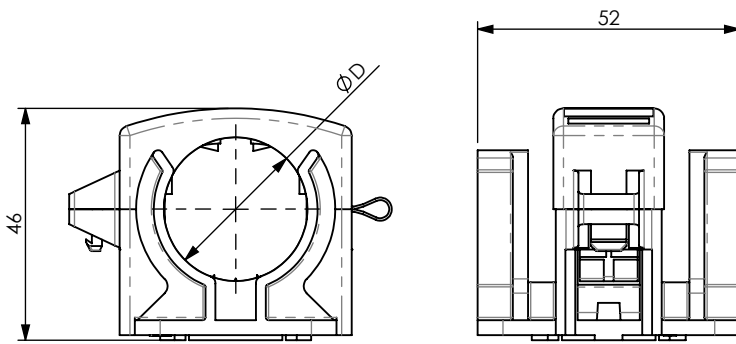

A) SPECIFICATIONS

Cable clamp. Material: P.A.6 UL94-V0
Self Extinguishing, black colour,
halogen free (according to UL94-V0).
1) Elastic provisional pre-fixing of cable.
2) Security locking system.

B) OPERATING TEMPERATURE

Working temperature : $-40^{\circ}\text{C} +125^{\circ}\text{C}$.
Installation temperature : $-20^{\circ}\text{C} +60^{\circ}\text{C}$.

C) DELIVERY MODALITIES

Packing in boxes. Label indicating:
product code, article, quantity,
production batch, FIMO logo and figure.
(Customer code on request).

D) MOUNTING INSTRUCTIONS

RAC IST 021 REV2

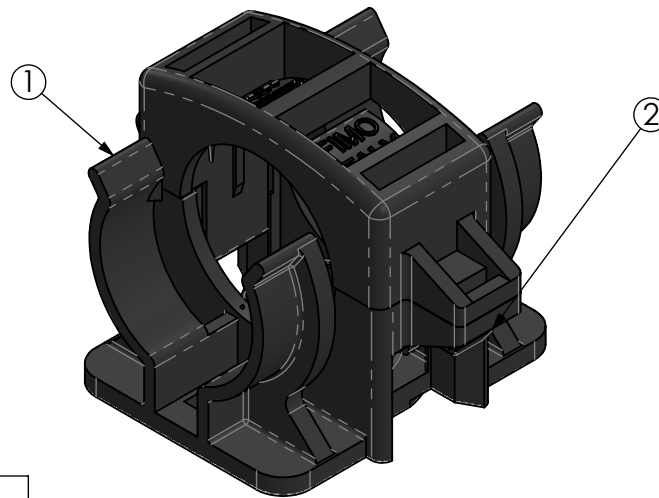

code	6150000078
article	RAC+ 7/8"

D		
26-30	50	0.0279kg

RI	DATE	DR	DATE	AP	Description: RAC+ 7/8" Radiating Cable Clamps
02					
01					
00	06/12/2016	E.B.	06/12/2016	A.V.	
1 ST EMISSION					
					Use: Installation of radiating cables in tunnel