

PRODUCT DATA SHEET

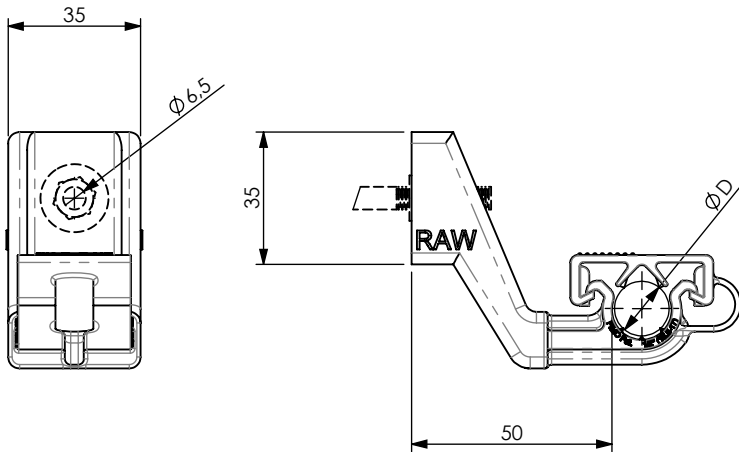

A) SPECIFICATIONS

1 Cable clamp. Material: PA6-VO, black colour, self extinguishing, halogen free (according to UL94-VO).

B) OPERATING TEMPERATURE

Working temperature : -40°C +125°C.
Installation temperature : -20°C +60°C.

C) DELIVERY MODALITIES

Packing in boxes. Label indicating: product code, article, quantity, production batch, FIMO logo and figure. (Customer code on request).

D) MOUNTING INSTRUCTIONS

IT043

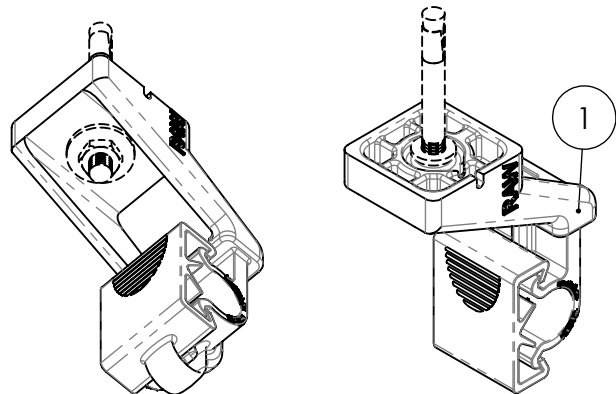

code	6150015012
article	RAW 1/2"-50

D		
15.5-17	50	0.2389kg

RI	DATE	DR	DATE	AP	Description: RAW 1/2"-50 Radiating Cable Clamps
02					
01					
00	05/12/2016	E.B.	05/12/2016	A.V.	
1 ST EMISSION					
					Use: Horizontal or vertical installation of radiating cables in tunnel * Suitable for installation in high speed railway tunnel application (350 km/h)