

PRODUCT DATA SHEET

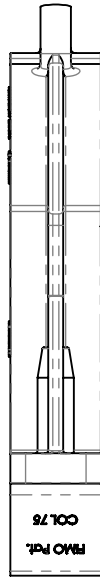
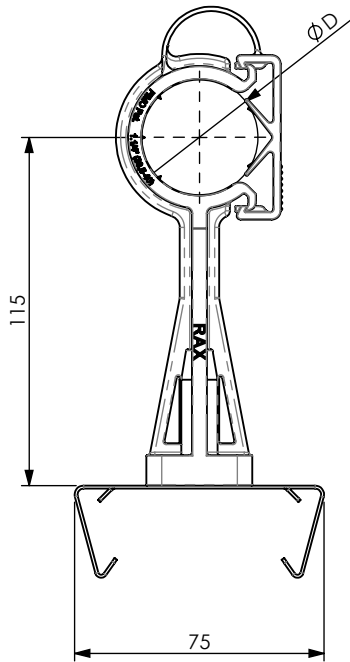

A) SPECIFICATIONS

- 1 Cable clamp. Material: PA6-VO, black colour, self extinguishing, halogen free (according UL94-VO).
- 2 Stainless Steel SNAP ON CLIP.
- 3 Stainless Steel 6x30 WOOD screws.

B) RESISTANCE TESTS

Working temperature : -40°C +125°C.
Installation temperature : -20°C +60°C.

C) DELIVERY MODALITIES

Packing in boxes. Label indicating: product code, article, quantity, production batch, FIMO logo and figure. (Customer code on request).

D) MOUNTING INSTRUCTIONS

On request

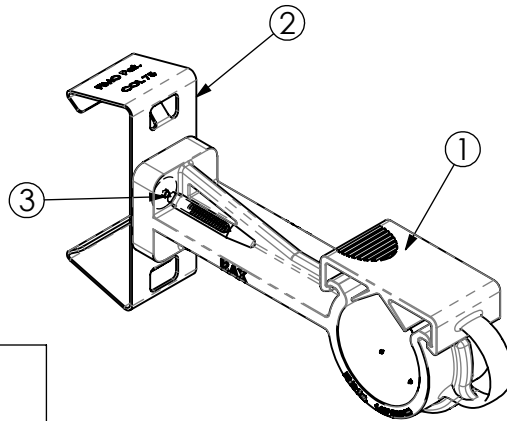

code	6150020114.75
article	KIT RAX 1.1/4" + COL 75

D		
38.5-40	50	0.0940kg

RI	DATE	DR	DATE	AP	Description: KIT RAX 1.1/4" + COL 75 Radiating Cable Clamps
02					
01	03/04/2014	E.B.	03/04/2014	A.V.	
00	04/11/2013	E.B.	04/11/2013	A.V.	
1 ST EMISSION					
					Use: Fixing of radiating cables on profiles/sections