

PRODUCT DATA SHEET

A) SPECIFICATIONS

- 1 Cable clamp. Material: PA6-VO, black colour, self extinguishing, halogen free (according to UL94-VO).
- 2 Stainless Steel RSD safety clamp

B) OPERATING TEMPERATURE

Working temperature : $-40^{\circ}\text{C} + 125^{\circ}\text{C}$.
 Installation temperature : $-20^{\circ}\text{C} + 60^{\circ}\text{C}$.

C) DELIVERY MODALITIES

Packing in boxes. Label indicating: product code, article, quantity, production batch, FIMO logo and figure. (Customer code on request).

D) MOUNTING INSTRUCTIONS

IT043

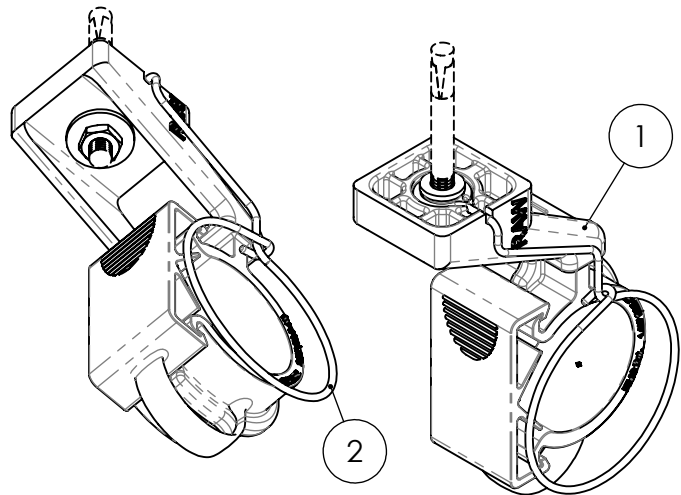
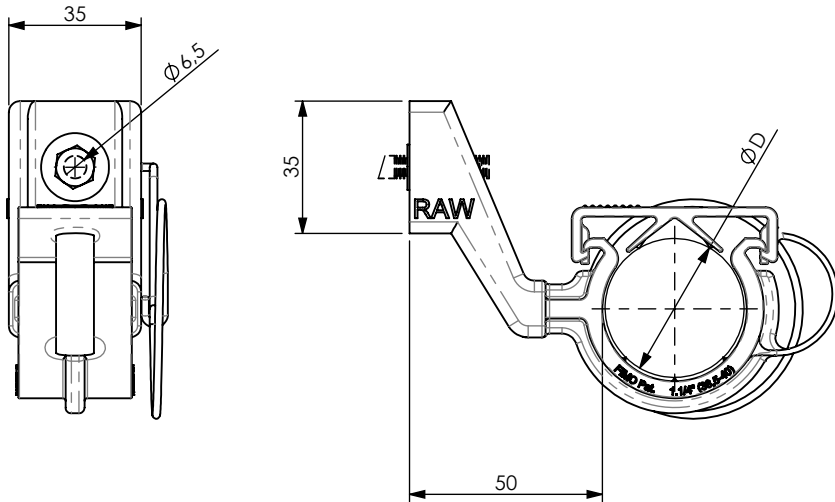

code	6150215114
article	RAW 1.1/4"-50 + RSD 1.1/4"-50

D		
38.5-40	50	0.0629kg

RI	DATE	DR	DATE	AP	Description: RAW 1.1/4"-50 + RSD 1.1/4"-50 Radiating Cable Clamps
02					
01					
00	19/02/2015	E.B.	19/02/2015	A.V.	
1 ST EMISSION					



Use: Horizontal or vertical installation of radiating cables in tunnel

* Suitable for installation in high speed railway tunnel application (350 km/h)