

Quantum Ultra® Series Videowall Processors • Setup Guide

IMPORTANT:
Go to www.extron.com for the complete user guide, installation instructions, and specifications before connecting the product to the power source.

The Extron Quantum Ultra Series, consisting of the Quantum Ultra 610 and 305, the Quantum Ultra II 610 and 305, and the Quantum Ultra Connect 128 and 84 Videowall Processors, are modular 4K video processors that support ultra-high resolutions up to 2560x1600 and 4096x2160 (4K) @ 60 Hz on inputs and outputs. All models provide customizable output resolutions, input and output image rotation, and mullion compensation. USB, RS-232, and Ethernet interfaces also provide direct connections for control systems.

- The **Quantum Ultra 610** has a 6U, 10-slot card frame, or chassis, while the **Quantum Ultra 305** has a 3U chassis with five card slots. These models support multiple videowalls with mixed resolutions and screen orientations. They also support edge blend compensation, window border styles, and a variety of source types including picture, RSS, Text, Clock, and VNC. The optional IN SMD 100 input card decodes and displays multiple simultaneous MPEG2, Motion JPEG, and H.264 video streams at up to 60 frames per second. Each input card contains four HDMI or two LAN connectors. The output cards contain either four HDMI or four DTP connectors. Both chassis support any combination of input and output cards. Additional inputs and outputs can be added to a system with use of one or more additional chassis.
- The **Quantum Ultra II 610** and **Quantum Ultra II 305** have the same features as their respective Quantum Ultra 610 and Quantum Ultra 305 counterparts, described above. In addition, these models support the IN4HDMI 4K PLUS input and OUT4HDMI 4K PLUS output cards, which provide 4K @ 60 Hz capability on each of the four HDMI connectors.
- The **Quantum Ultra Connect 128 and 84** have fixed configurations. The **Quantum Ultra Connect 84** has two HDMI input cards and one HDMI output card, while the **Quantum Ultra Connect 128** has three HDMI input cards and two HDMI output cards. These card configurations cannot be modified by the user.

NOTE: The **Expansion In and Expansion Out cards** provide another option for the Quantum Ultra 610 and 305, and Quantum Ultra II 610 and 305 (Quantum Ultra Connect models do not support expansion cards). These input and output cards enable up to five Quantum Ultra chassis to be connected together and managed from one primary chassis. Using the expansion cards, a Quantum Ultra system can be expanded to up to 42 input and output cards (see the *Quantum Ultra Expansion System Setup Guide*, provided with the expansion system, for information on setting up these models).

Control methods for all models include Extron Videowall Configuration Software (VCS), available on the [Extron website](http://www.extron.com), which provides a means of configuring videowall displays and saving window presets. Control is also available via Simple Instruction Set™ (SIS™) or the Express Mobile Software (EMS) for Quantum Ultra on an iOS®, Android®, or Microsoft® tablet device.

This setup guide provides step-by-step instructions for an experienced user to set up and configure a Quantum Ultra Series device. In this guide, the terms “Quantum Ultra Series,” “Quantum Ultra Series device,” “unit,” and “processor” are used interchangeably to refer to all models in the series.

Installation Steps

WARNING: To avoid electric shock or product damage due to condensation, always let the Quantum Ultra become acclimated to ambient temperature and humidity for at least 30 minutes before switching it on. This is very important when you are moving the unit from a cold to a warm location.

AVERTISSEMENT : Afin d'éviter un risque éventuel de choc électrique ou d'endommagement du produit dû à la condensation, laissez toujours le temps à la source d'alimentation de le Quantum Ultra à la température et à l'humidité ambiantes, pendant au moins 30 minutes, avant de les brancher. Ceci est particulièrement important lorsque vous déplacez l'unité depuis un lieu frais vers un lieu chaud.

ATTENTION:

- All structural steps and electrical installation must be performed by qualified personnel in accordance with local and national building codes and electrical codes.
- Toute étape structurelle et installation électrique, doit être effectuée par un personnel qualifié, conformément aux codes du bâtiment, aux codes incendie et sécurité, et aux codes électriques, locaux et nationaux.

1. **Disconnect power** from all equipment.
2. (Optional) **Mount the unit to a rack** using the supplied screws (see the image at right).

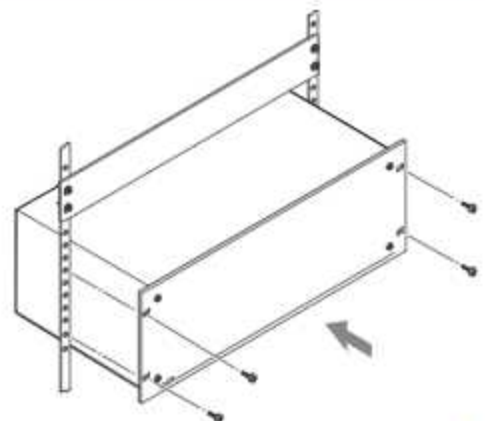

Quantum Ultra Series • Setup Guide (Continued)

- 3. Connect the video inputs and outputs.** Connect HDMI sources to connectors on the installed HDMI input cards. If IN SMD 100 input cards are installed (Quantum Ultra and Quantum Ultra II only), connect the LAN connectors on the cards to a network for streaming sources. Connect DTP receivers (Quantum Ultra and Quantum Ultra II only) or HDMI displays to connectors on the output cards. Secure each HDMI device cable to the connector with a provided LockIt® HDMI Cable Lacing Bracket.
- 4. Connect a control device** — For remote control, connect a control device or a computer to:
 - The RJ-45 LAN A to enable configuration of the Quantum Ultra Series device via SIS commands, VCS, or EMS
 - (Optional) The USB mini B Config connector to enable configuration and control via SIS commands or VCS
 - (Optional) The 3-pole captive screw RS-232 connector to enable serial control via SIS commands
- 5. Connect power** to the Quantum Ultra or Ultra II primary and redundant (optional) IEC connectors.
- 6. Power on the unit and all connected devices.**
- 7. Download and install VCS on your computer.**
- 8. Configure sources, displays, EDID, and presets** for your videowall using VCS (see [Configuring the Videowall Using VCS](#) on page 4).

Rear Panel Features and Connections

NOTE: Figure 1 shows the rear panel of a Quantum Ultra 610. The Quantum Ultra II 610 rear panel is identical except for IEC C20 AC connectors and the product name in the upper-left corner. The Quantum Ultra and Ultra II 305, Ultra Connect 84, and Ultra Connect 128 have similar rear panels except they are 3U high, have five card slots, and have no redundant power connector.

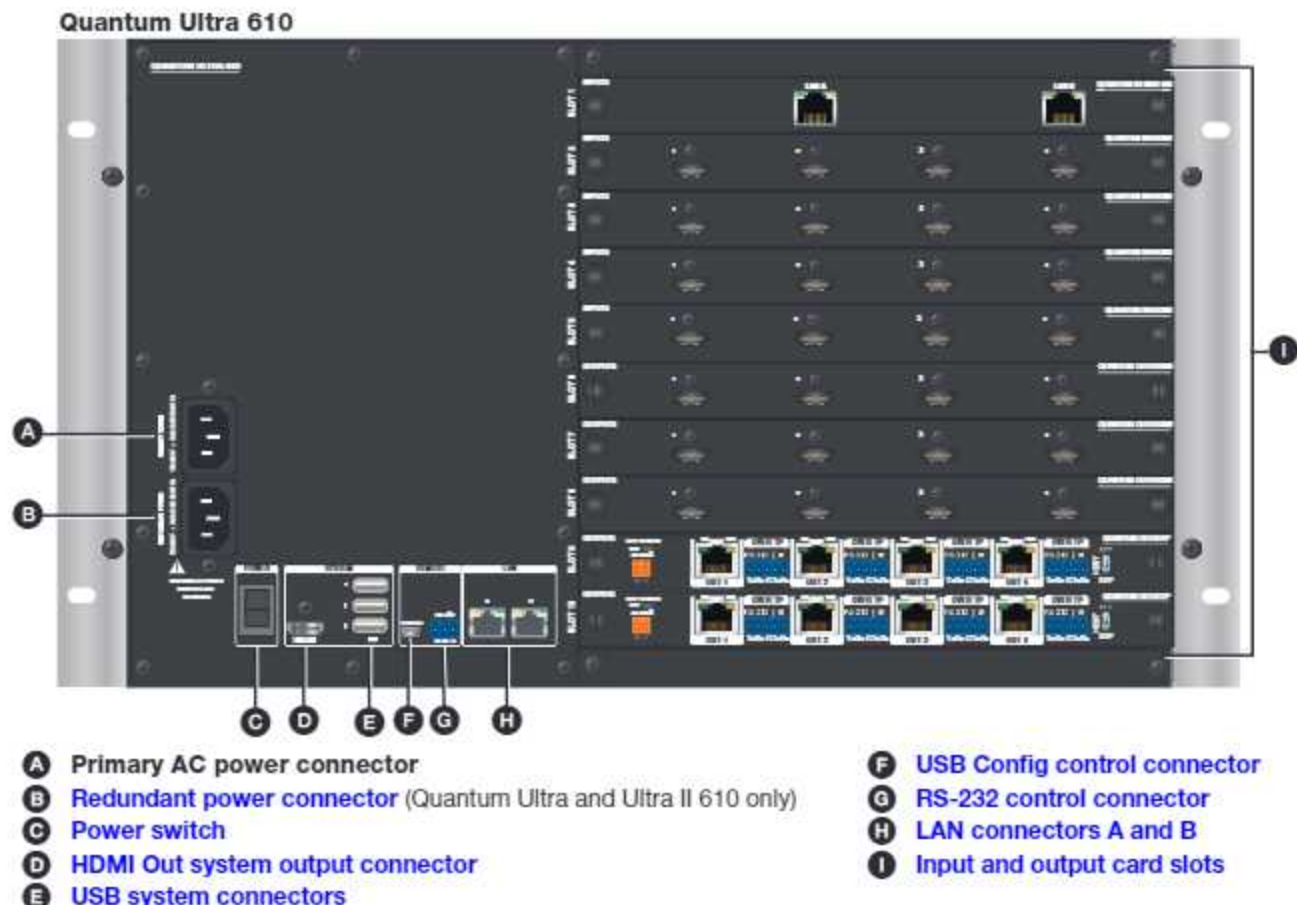
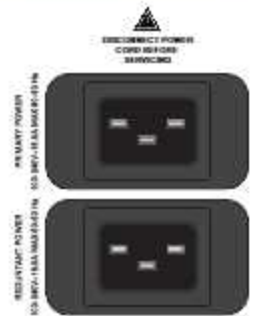

Figure 1. Quantum Ultra 610 Rear Panel

- A Primary AC power connector** — Connect AC power to this IEC connector for the primary power supply.

- B Redundant power connector (Quantum Ultra 610 and Ultra II 610 only)** — (Optional) Connect a second AC power source to this IEC connector for the secondary power supply to provide uninterrupted operation in the event of failure of the primary supply.

NOTE: The Quantum Ultra II 610 has IEC C20 power connectors (shown at right), while the Quantum Ultra and Quantum Ultra II 305 models have standard US IEC connectors. The Quantum Ultra II requires an IEC C19 power cord to connect AC power.



For Quantum Ultra II 610 only:

- **North America** — Connect the equipment to a 100-240 VAC, 50-60 Hz, 20 A protected power source using a power supply cord with a C19 coupler and either a NEMA 5-20 plug (125 V) or NEMA 6-20 plug (250 V).
 - **Other regions** — Connect the equipment to a 200-240 VAC, 50-60 Hz power source using a power supply cord with a C19 coupler and a plug configuration of 7 A minimum.
- C Power switch** — Press this momentary rocker switch to power the unit off and on.
- If the unit is **off**, momentarily pressing this switch powers it on.
 - If the unit is **on**, pressing and holding this switch for approximately 5 seconds powers it down.
 - If the unit is logged into the Quantum Ultra Series device operating system, a momentary press of this switch powers off the device.
- D HDMI Out system output connector** — (Optional) Connect an HDMI monitor to this female HDMI connector to view activity and interactions with the embedded operating system.
- E USB system connectors** — (Optional) Connect a flash drive or human interface devices (HIDs) such as a keyboard or mouse to one or more of these three USB A connectors to enable interaction with the embedded operating system.
- F USB Config control connector** — Connect a computer to this USB connector to enable control of the Quantum Ultra Series device via VCS and SIS commands.
- G RS-232 control connector** — Connect a control system or computer to this 3-pole, 3.5 mm captive screw connector to enable control of the Quantum Ultra Series device via SIS commands. RS-232 protocol for this port is 9600 baud, 1 stop bit, no parity, 8 data bits, and no flow control.
- H LAN connectors A and B** — Connect one or both of these RJ-45 Ethernet connectors to a network to access:
- A computer with VCS and, optionally, EMS installed, to set up the videowall (see [Configuring the Videowall Using VCS](#) on page 4).
 - A control device such as an Extron IP Link Pro or IPCP Pro for AV control of the Quantum Ultra Series device.
 - A network with Virtual Network Computing (VNC) servers to stream desktops to the Quantum Ultra or Ultra II device.
- I Input and output card slots** — Each of these slots supports either an input or an output card. At least one input and one output card must be installed.
- **Inputs** — Each HDMI and HDMI 4K PLUS input card has four female HDMI connectors, so that up to four HDMI sources can be connected to it. For the Quantum Ultra and Ultra II 610 and 305, each IN SMD 100 input card has two LAN connectors, each of which can be connected to a network to enable decoding and displaying of multiple streams.
 - **Outputs** — Each HDMI and HDMI 4K PLUS output card has either four HDMI connectors or, for Quantum Ultra and Ultra II 610 and 305, four DTP connectors. Up to four HDMI displays or DTP receivers can connect to these cards.
 - The Quantum Ultra Connect 84 has two HDMI input cards and one HDMI output card, while the Connect 128 has three HDMI input and two HDMI output cards. These card configurations are fixed and cannot be modified by the user.

NOTE: Dual link signals are not supported. To connect DVI sources or displays to an HDMI connector, use a DVI-to-HDMI adapter.

Quantum Ultra Series • Setup Guide (Continued)

Card Installation Order

When the Quantum Ultra Series device is assembled at the factory, all the input cards are installed in slots above the output cards in the chassis. If installing cards yourself, **do not** intersperse input cards with output cards.

NOTE: The expansion output and input cards have special rules for placement in card slots (see the *Quantum Ultra Expansion System Setup Guide*, provided with the expansion system, for more information).

Each card slot can contain either an input or an output card (at least one input and one output card must be installed). However, because all the input cards must be installed together above the output cards in the chassis, slot 1 cannot contain an output card and slot 10 of the 610 models or slot 5 of the 305 models cannot contain an input card.

All input cards of the same type (IN SMD 100, HDMI, and HDMI 4K PLUS) must be installed in adjacent slots, as must all output cards of the same type (HDMI, DTP, and HDMI 4K PLUS). **Do not** intersperse different card types.

- Install the cards in this order: IN SMD 100, IN4HDMI, IN4HDMI 4K PLUS, OUT4HDMI, OUT4DTP, OUT4HDMI 4K PLUS.
- Do not leave empty slots **between** cards in the chassis. Empty card slots must be at the **bottom** of the card stack.

Configuring the Videowall Using VCS

This section describes how to set up the videowall (create a project) using the VCS program to configure and control the Quantum Ultra Series from the computer. For detailed information, see the *VCS Help File*, accessible from within VCS.

Starting VCS

1. Download VCS from www.extron.com (see the *Quantum Ultra Series User Guide*, also available on the Extron website, for instructions).
2. Open the software program either by double-clicking the VCS icon (shown at right) that is placed on your desktop during installation, or by clicking **Start > Extron Electronics > Videowall Configuration Software**. The Extron VCS program opens with the Start screen, **Connect** tab.
3. Click the **New** tab (1) to open the **Create New Project** tab (see figure 2).



Figure 2. VCS Start Screen, Create New Project Tab

4. Select the **Quantum Ultra / Quantum Ultra II** radio button (2) and click the **Create** button (3). VCS searches for Quantum Ultra Series devices on the network. The **New Project** screen is displayed. The **Select Device(s) to Add** panel (see figure 3, 1 on the next page) displays all detected devices of the type selected on the **Create New Project** screen.

NOTE: A gateway IP address is required on the PC running VCS, in order for the Quantum Ultra Series device to be detected. The gateway address need not be valid or on the same subnet.



Figure 3. New Project Screen

5. Locate your Quantum Ultra Series device in the Select Device(s) to Add panel, and click the Add to System button at the left of the device name. If a project already exists on the selected device, a prompt opens, asking if you want to apply your new project to the device (deleting the previous project). Click OK to continue creating the project (or Cancel to stop the procedure). Connection information is displayed in the System Devices panel. If the computer is successfully connected to the device, the word Connected is displayed, preceded by a green dot, in the System Devices panel (see figure 3, 2).

NOTES:

- Multiple Quantum Ultra and Ultra II 610 and 305 devices can be added to a product. Only one Quantum Ultra Connect device can be added.
- If you do not see your device in the Devices panel, you can add it manually (see "Manually adding devices").

6. Edit IP address settings for your device as needed.
 - a. In the Select Device(s) to Add panel, click the Edit button (see 1 in the image below).

| | Model | IP Address | Device Name | Connection |
|---------------|-------------------|-----------------|----------------|------------|
| Add to System | Quantum Ultra 610 | 192.168.254.254 | QU610-AB-CD-EF | TCP/IP |

- b. The Communication Settings dialog box opens. In this window, enter a new IP address and edit other IP settings as desired.

To enable Dynamic Host Configuration Protocol (DHCP), select the DHCP checkbox. When this box is selected, an available IP address is assigned automatically to the Quantum Ultra Series device when it is connected to a supporting network. (When this checkbox is selected, all other IP settings fields become read-only.)

If you added this device manually, click the Device Settings button (shown at right) on the VCS taskbar. On the Device Details screen, click the Communication Settings button to display the Communication Settings window. If the device cannot be detected or manually added, connect to it using USB or RS-232 and configure the IP address using SIS commands.



Manually adding devices

If you do not see your Quantum Ultra Series device in the Select Device(s) to Add panel (see step 4 starting on the previous page), you can add the device manually:

1. Click the Manually Add Device button (see figure 3, 4). The Manually Add Device window opens (shown at right).
2. In the IP Address field, enter the address of the Quantum Ultra Series device to be connected and select the Pull from Hardware radio button (see 1 in the image at right).
3. Select the device type from the Device Type drop-down list. Quantum Ultra or Ultra II devices can be selected if a Quantum Ultra or Ultra II 305 or 610 project was created. Quantum Ultra Connect devices can be selected if a Quantum Ultra Connect 84 or 128 project was created.



Quantum Ultra Series • Setup Guide (Continued)

- Click Add. The connection information for the device is displayed in the System Devices panel (see figure 3, 2 on the previous page). A unit added by this method is **not** displayed in the Select Device(s) to Add panel.

Setting Up the Videowall

To use the VCS program to configure the videowall, start by setting up a project. In the project, you can define the Quantum Ultra Series processors, create one or more videowalls, set up video sources and outputs, and create presets. At the top of the Quantum Ultra Series screen is a row of task buttons. After connecting to the desired Quantum Ultra Series device (processor or chassis) or devices, click the task buttons to access screens for the setup tasks. For best results, perform the following setup steps in the order shown.

Wall Configuration

Click the Wall Configuration button (shown at right) to configure the outputs and to select the output channels on the Quantum Ultra Series device for the videowall. The Wall Configuration window opens, providing a Canvas to set up the wall (see figure 4).



- Name the Canvas.** By default, the first videowall configuration (Canvas) you define is named Canvas 1 (see figure 4, 1). In the Canvas Name field, you can customize the name if desired (2). Each Canvas that is created (a maximum of 10) is assigned an incremented number that appears in the Canvas ID field and is used in SIS commands.

NOTE: The Quantum Ultra Connect models support only one canvas.

- Select the number of displays.** In the spin boxes labeled Number of Displays (3) select or enter the number of displays for the columns and the rows of the videowall. In the example in figure 4, the wall has five columns by three rows (4).

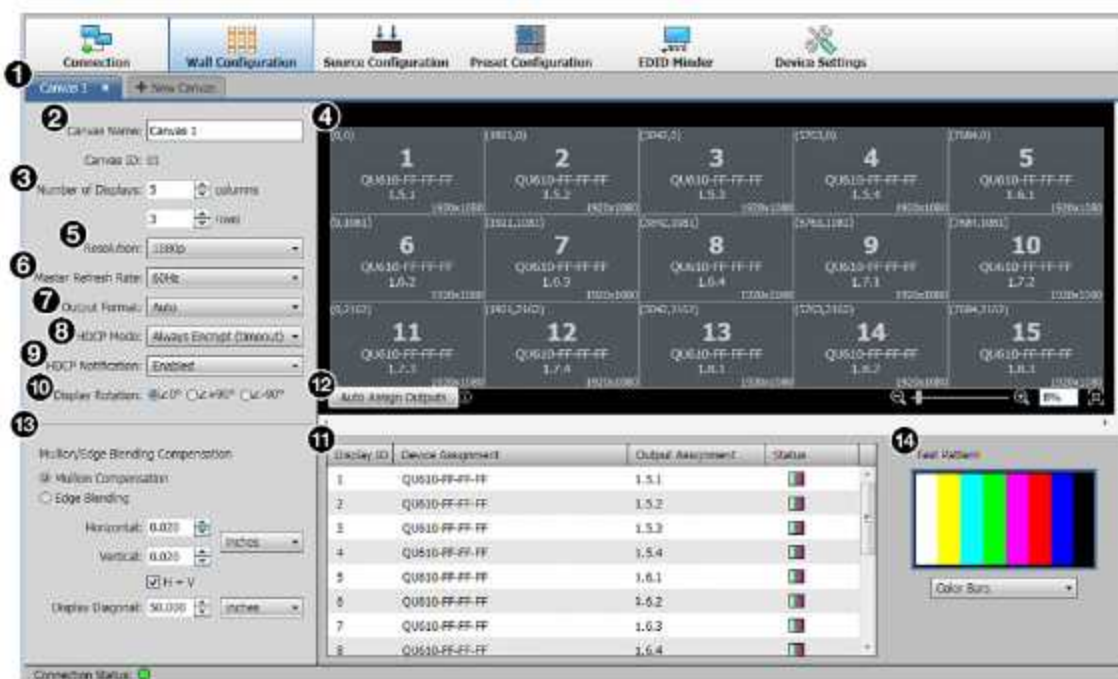

Figure 4. Wall Configuration Window

- Configure the outputs.** The settings on the menus in the output configuration panel apply to **all** displays in the Canvas:

- Resolution** (see figure 4, 5) – From this drop-down list, select the output resolution for the displays.
- Master Refresh Rate** (6) – From this drop-down list, select the refresh rate for the displays.

NOTE: Quantum Ultra and Ultra II 610 and 305 only: This rate not only applies to all the displays on the first Canvas, but limits selectable refresh rates on all other Canvases that are added (see the *VCS Help File* to use multiple Canvases).

- Output format** (7) – From this drop-down list, select the output format (AUTO, DVI RGB 444 or HDMI RGB 444). The default is Auto.
- HDCP Mode** (8) – From this drop-down list, select how to manage HDCP encryption on the outputs. You can select to always encrypt the output (default), to never encrypt the output, or to attempt to encrypt the output for 1 minute, then revert to an unencrypted state (not allowing display of HDCP encrypted sources if authentication with the sink device fails).

- **HDCP Notification** (9) — From this drop-down list, select to enable or disable a green screen notification when the input signal contains HDCP-protected content and the outputs cannot be encrypted.
- **Display Rotation** (see figure 4, 10 on the previous page) — In this panel, select the radio button for the angle at which the displays physically rotate: +90° (90 degrees clockwise), -90° (90 degrees counterclockwise) or 0° (no rotation). The example at right shows a videowall that has four rotated displays.

NOTE: The OUT4HDMI cards support output rotation only on the even numbered channels and disables the odd numbered channels. The OUT4HDMI 4K PLUS cards support output rotation on all channels.



4. **Define the Quantum Ultra Series device and output** in the output assignment panel (11) for each display on the videowall, using either of the following methods:

- **Automatic method** — (Recommended) Click the **Auto Assign Outputs** button (12) to automatically assign a device and an output channel to each display in the videowall. Output card slot and connector numbers are assigned to the displays in numerical order. The displays are shown on the Canvas numbered from left to right, starting in the upper-left corner with Display 1.

The number format for the display locations is *n.n.n*. The first numeral indicates the chassis number. This number is 1, except in an expansion system (see the *Quantum Ultra Expansion System Setup Guide*, provided with the expansion system, for more information). In all systems, the second numeral is the card slot, and the third is the connector (channel) number. For example, 1.9.2 represents chassis 1, card slot 9, connector 2.

- **Manual method** —

- Select a Quantum Ultra Series device** for a display on the videowall. Click <Undefined> beside the number of the display to be assigned, and select a device from the drop-down list.
- Select a chassis, output card, and slot number** for the display. Click <Undefined> in the Output Assignment column, in the row of the display to be assigned. On the output drop-down list, all output connectors are listed in order by chassis number (unless the unit is part of an expansion system, this number is always 1), then card slot number, then connector number.

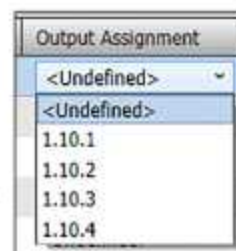

In the example at right, number 1.10.4 represents connector 4 on the output card in slot 10 of chassis 1.



Repeat these steps for each display on the videowall to which you want to assign a Quantum Ultra Series device and output connector. (This guide assumes you are configuring a videowall with one device. For information on configuring a videowall with multiple processors, see the *VCS Help File*).

- In the **Mullion/Edge Blending Compensation** panel (13) select either of the following radio buttons (for more detailed information, see the *VCS Help File*):
 - **Mullion Compensation** — Displays controls that let you specify the mullion space around the displays in pixels, inches, centimeters, or millimeters. If not using pixel values, you must also enter the diagonal size of the screen.
 - **Edge Blending** (Quantum Ultra or Ultra II 610 and 305 only) — Displays controls that let you specify the amount in pixels of horizontal and vertical overlap of the videowall outputs.
- If desired, select a test pattern from the menu in the **Test Pattern** panel (14) to aid in optimizing the wall configuration.

Source Configuration

Each source used in a project must have a corresponding source definition in VCS. To configure the sources:

- On the taskbar, click the **Source Configuration** button (see figure 5, 1 on the next page) to display the **Source Configuration** screen.
- Select a source type.** In the **Source Configuration Tree** (left panel), click a source type to add (2). Depending on the cards installed in your unit, HDMI, IP Source, or both may be listed. Picture, Clock, VNC, Text, and Really Simple Syndication (RSS) source types are always available for configuration.

NOTES:

- Source type selection is available only on Quantum Ultra or Ultra II 610 and 305. The Quantum Ultra Connect models support only HDMI sources.
- The number format for the sources listed in the source tree is *n.n.n*, same as the outputs on the Wall Configuration screen. The first digit indicates the chassis order number (if it is not an expansion system, this number is always 1). The second digit is the card slot and the third digit is the connector (channel) number. For example, 1.4.1 represents chassis 1, card slot 4, connector 1.

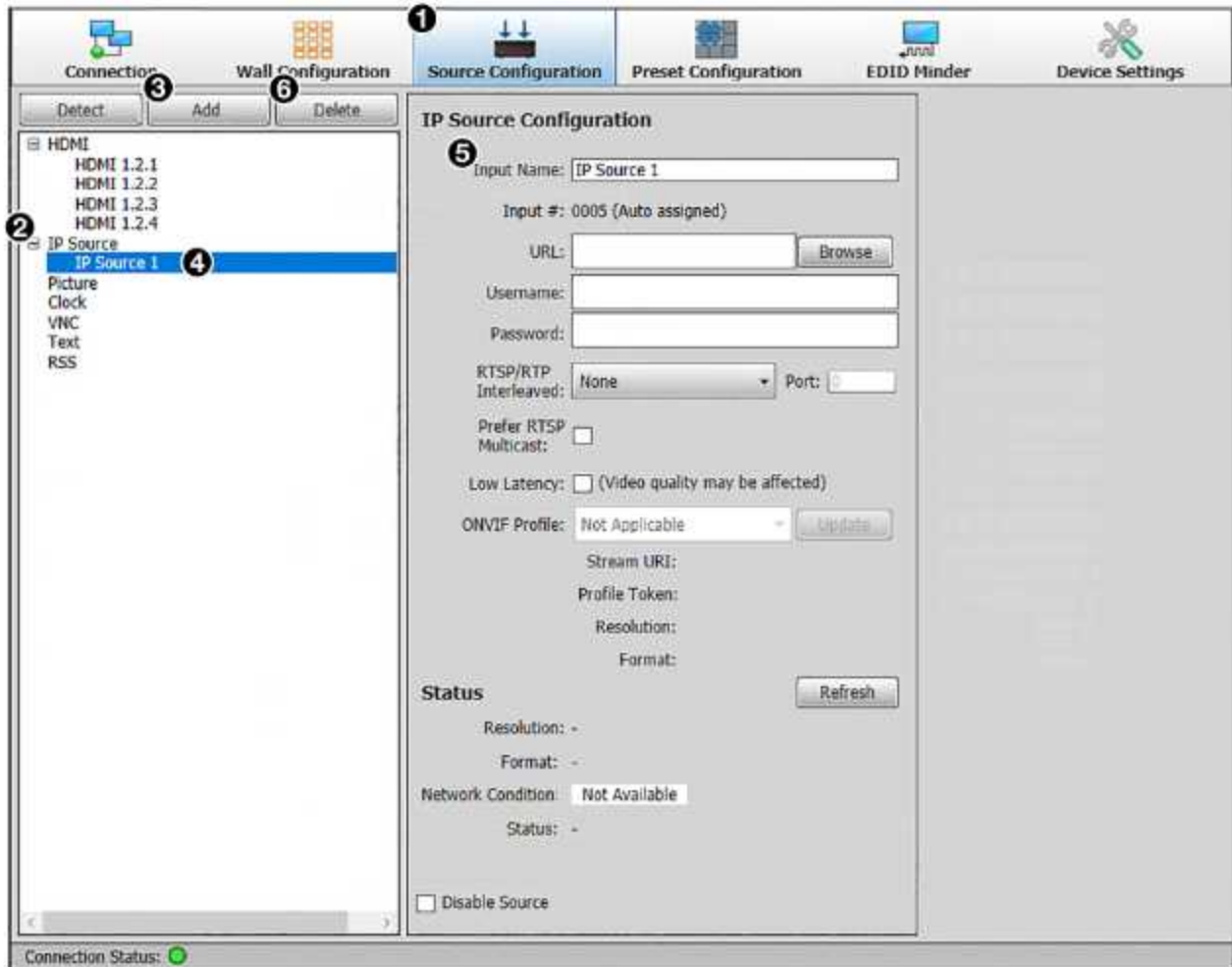

Figure 5. Source Configuration Window (IP Source Example)

- Add a source.** Click Add (see figure 5, ③) to add a source of the selected type, or right-click the source type to add and select Add from the pop-up menu. One or more source names are added in the Source Configuration Tree below the source type (④).

NOTE: The number of sources added depends on the cards installed in your unit. For example, if one HDMI input card is installed, selecting HDMI displays four source names, as shown in figure 5).

- Configure the selected source.** In the Source Configuration Tree, click the source name to be configured. (It may be necessary to click the + sign to the left of the source type to expand the source list before selecting a source). A configuration window for the selected source opens in the center panel of the screen, with the default name of the source entered in the Input Name field (⑤). Fill in the information in the source configuration window to set up the source.

NOTE: Quantum Ultra and Ultra II 610 and 305 only: If adding a picture or an IP source, click the Detect button (⑥) above the Source Configuration Tree to:

- Open a window listing the URLs of available streams (IP Source), detected using Session Announcement Protocol (SAP) and Open Network Video Interface Forum (ONVIF) protocols. By default, the IP addresses on the IN SMD 100 cards are set to DHCP On.
- List the image files available on your Quantum Ultra Series chassis (Picture).

5. **Add more sources as desired.** Repeat steps 2 through 4 to add and configure additional sources (see the *VCS Help File* for details on configuring the different sources).

Preset Configuration

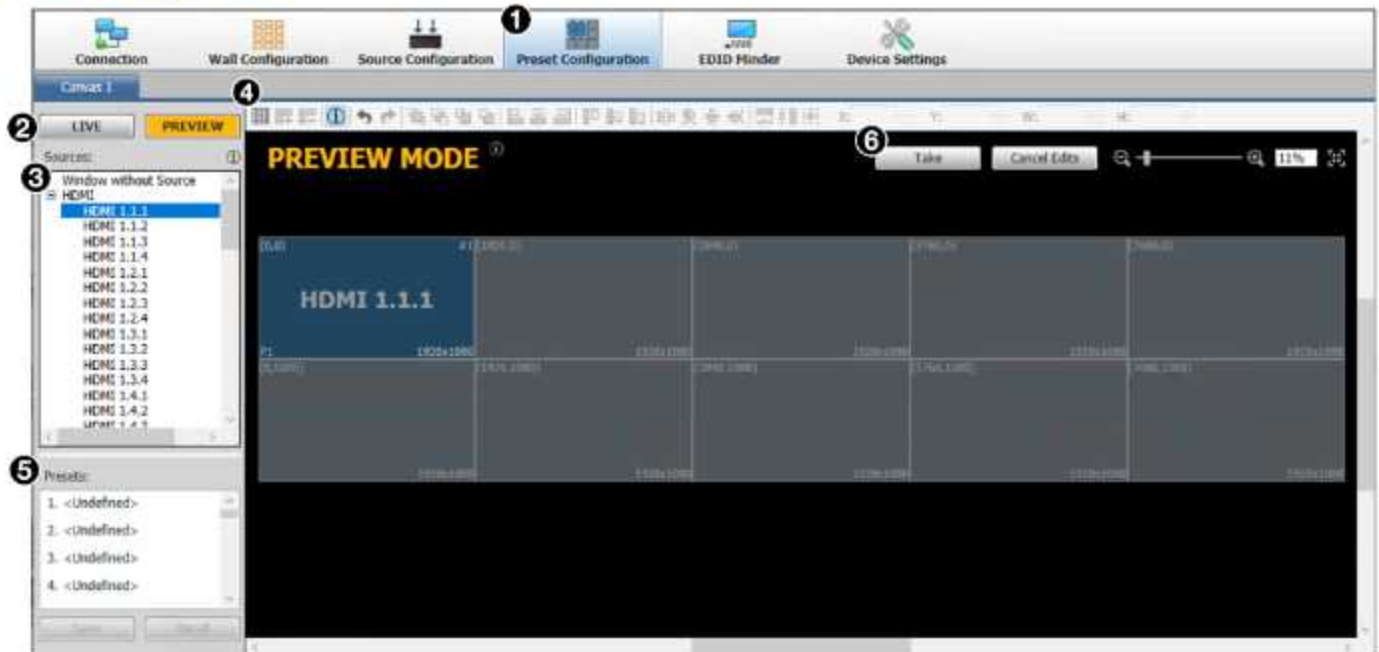

Figure 6. Preset Configuration Window

A window preset, or scene, is a set of one or more windows in which video sources are displayed on a videowall. Window layout parameters, including size, position, and content, are stored in the presets. Presets can be recalled and displayed using VCS or SIS commands (see [Recall window preset](#) on page 10).



1. On the taskbar, click the **Preset Configuration** task button to display the preset configuration workspace (see figure 6, 1). The Canvas in this workspace is a virtual representation of the videowall you set up on the **Wall Configuration** screen (see [Configuring the Videowall Using VCS](#) on page 4).
2. Click the **Live** or **Preview** button (2) to select the mode in which you want to configure the preset (see the *VCS Help File* for more information on configuration modes).
3. Specify the sources to be displayed on the videowall by adding source windows:

- a. Click on a source name (HDMI, IP, Picture, Clock, VNC, Text, or RSS) in the **Sources** (left) panel (3), and drag it to the desired location on the Canvas. A window containing the source name appears on the Canvas (see the example at right). You can also drag in a **Window without Source**, for which no input signal is displayed in the window on the Canvas.



- b. Configure the source window by doing the following as needed:

- Resize it by clicking on it and dragging the resizing handles at the sides and corners.
- Reposition it by dragging and dropping it at the desired location on the Canvas.
- Double-click on it to fill the display or displays on which it was placed.
- Change the source in the window by right-clicking and dragging a different source onto the source window. Drop the new source when the target window turns red (shown at right).
- Right-click on it and select **Window Configuration** from the menu. In the **Window Configuration** dialog box, specify parameters for the window border, text on the border, and overlay text (Quantum Ultra and Quantum Ultra II only).



4. If a window completely or partially covers another window, set the priority for each window by selecting the window, then clicking a priority icon on the toolbar above the Canvas (4). The priority number of the window (P1, P2, and so on) is displayed in the lower-left corner of the window on the Canvas (see the image in step 3a, above). You can also use this toolbar to align multiple windows with each other and to set the size of multiple windows on the Canvas.



5. When finished, save the window layout as a preset as follows:
 - a. In the Presets list in the lower-left corner of the screen (see [figure 6, 5](#) on the previous page), select a slot for the preset to be saved.
 - b. Click Save. The preset slot becomes a text field with the label *Window Preset nnn* (where *nnn* is the three-digit preset number that indicates the preset slot number).
 - c. Enter a name for the preset (32 characters maximum) or click outside the text field to keep the current name.
6. If configuring in Preview mode, click the Take button (6) if you want to apply the preset to all displays in the system.

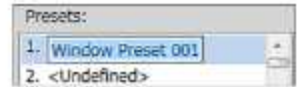

Basic SIS Commands

The Quantum Ultra Series can be controlled with SIS commands via a USB, RS-232, or LAN connection. The following table lists some basic commands. For a full list of SIS commands and variables see the *Quantum Ultra Series User Guide*, available at www.extron.com.

| Command | ASCII Command (Host to Processor) | Response (Processor to Host) | Additional Description |
|--|--|---------------------------------|--|
| Input Selection | | | |
| Select input | [X3]*[X3]*[X1]! | Grp[X3]*Win[X3]*In [X1]↵ | Select input [X1] for window [X3] on Canvas [X3]. |
| View current input | [X3]*[X3]: | [X1]↵ | View current input [X1] in window [X3] on Canvas [X3]. |
| Window Presets | | | |
| Recall window preset | $1*\text{[X3]*[X29]}$ | 1Rpr[X3]*[X29]↵ | Recall window preset [X29] on Canvas [X3]. |
| Recall preset with audio | $3*\text{[X3]*[X29]}$ | 3 Rpr[X3]*[X29]↵ | Recall window preset [X29] to canvas [X3] including audio tie. |
| Window Border Style (These commands apply to Quantum Ultra and Quantum Ultra II only.) | | | |
| Set window border style | $\text{[Esc] B [X3]*[X3]*[X79] WNDW}\leftarrow$ | Wdw B [X3]*[X3]*[X79]↵ | Set the border style of window [X3], on Canvas [X3], to [X79]. |
| View window border style | $\text{[Esc] B [X3]*[X3] WNDW}\leftarrow$ | [X79]↵ | View border style [X79] for window [X3] on Canvas [X3]. |
| Audio Selection | | | |
| Select audio source | $\text{[X3]*[X1]\$}$ | Grp[X3]*In[X1]*Aud↵ | Select audio from input [X1] for canvas [X3]. |
| IP Configuration (These commands apply only to the LAN A port. A Commit and Reboot command is required for changes to persist.) | | | |
| Set DHCP on and off | $\text{[Esc] [X10] DH}\leftarrow$ | Idh[X10]↵ | Enable or disable DHCP. |
| View DHCP setting | $\text{[Esc] DH}\leftarrow$ | [X10]↵ | View DHCP setting [X10]. Default is 0 (off). |
| Set IP address | $\text{[Esc] [X114] CI}\leftarrow$ | Ipi*[X114]↵ | Set the IP address for the unit to [X114]. |
| View IP address | $\text{[Esc] CI}\leftarrow$ | [X114]↵ | View IP address [X114]. |
| Rebooting the System | | | |
| Commit and reboot | $\text{[Esc] 1BOOT}\leftarrow$ | Boot1↵ | Commit changes and reboot Quantum Ultra. |
| KEY: | | | |
| [X1] | = Input (assigned by VCS): 0001 – 9999. Response is four digits with leading zeros. 0001 – 0999 = physical video connections on all Quantum chassis in the system. 1000 – 9999 = Sources defined in the system and not connected to an input card (Picture, RSS, VNC, Text, or Clock). | | |
| [X3] | = Canvas: 01 – 10. Response is two digits with a leading zero. | | |
| [X9] | = Window: 001 – 999. Response is three digits with leading zeros. | | |
| [X10] | = On or off: 0 = off (disabled), 1 = on (enabled). | | |
| [X29] | = Window preset: 001 – 128. Response is three digits with leading zeros. | | |
| [X79] | = Window border style preset: 000 – 127. 000 = no border. Response is three digits with leading zeros. | | |
| [X114] | = IP address in the format <i>nnn.nnn.nnn.nnn</i> . Default is 192.168.254.254. | | |

For information on safety guidelines, regulatory compliances, EMI/EMF compatibility, accessibility, and related topics, see the [Extron Safety and Regulatory Compliance Guide](#) on the Extron website.